

GALVANIZED TURNBUCKLES

TURNBUCKLE type A galvanized

marking: *nominal size

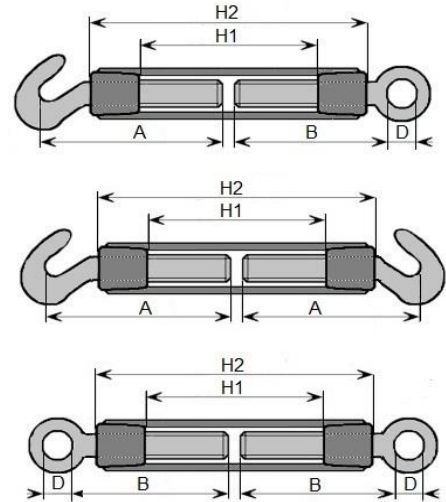

available: eye-eye, eye-hook, hook-hook

code	nominal size	approx. strength	H1	H2	A	B	D	weight
		[kg]	[mm]	[mm]	[mm]	[mm]	[mm]	
SCA05X070X-X	M 5	80	49	70	50	38	8	0,04
SCA06X110X-X	M 6	100	75	100	81	56	10	0,08
SCA08X125X-X	M 8	200	96	125	85	70	12	0,16
SCA10X150X-X	M 10	300	115	150	106	78	15	0,25
SCA12X190X-X	M 12	500	155	190	126	105	17	0,44
SCA16X245X-X	M 16	1000	195	245	152	140	20	0,85
SCA20X290X-X	M 20	1500	233	290	175	168	25	1,53
SCA24X335X-X	M 24	3000	265	335	225	195	32	2,71

TURNBUCKLE DIN1480 galvanized

marking: *nominal size

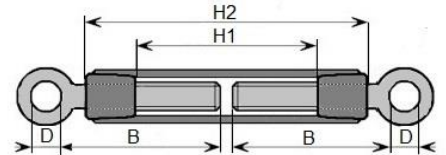

available: eye-eye

code	nominal size	approx. strength	H1	H2	B	D	weight
		[kg]	[mm]	[mm]	[mm]	[mm]	
SC16X170X-X	M 16	1770	115	170	110	20	0,89
SC20X200X-X	M 20	2700	132	200	140	22	1,55
SC24X255X-X	M 24	3920	175	255	175	30	3,14
SC30X255X-X	M 30	6250	165	250	185	32	4,09

TURNBUCKLE DIN1480 black

marking: *nominal size

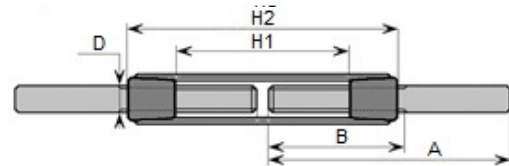

available: rod-rod

code	nominal size	approx. strength	H1	H2	A	B	D	weight
		[kg]	[mm]	[mm]	[mm]	[mm]	[mm]	
SCC08X110X-X	M 8	415	78	110	120	65	8	0,17
SCC10X120X-X	M 10	660	88	120	150	75	10	0,29
SCC12X120X-X	M 12	940	84	120	150	75	12	0,41
SCC16X170X-X	M 16	1800	115	170	200	100	16	0,95
SCC20X200X-X	M 20	2750	132	200	220	120	20	1,68
SCC24X255X-X	M 24	4000	175	255	260	150	24	2,85
SCC30X255X-X	M 30	6350	175	255	260	160	30	4,11

**BODY OF TURNBUCKLE
DIN1480 galvanized**

marking: *nominal size

code	nominal size	approx. strength	H1	H2	weight
		[kg]	[mm]	[mm]	
SCK08X110	M 8	415	81	110	0,09
SCK10X120	M 10	660	88	120	0,14
SCK12X120	M 12	940	82	120	0,20
SCK16X170	M 16	1800	115	170	0,43
SCK20X200	M 20	2750	132	200	0,76
SCK24X255	M 24	4000	175	255	1,36
SCK30X255	M 30	6350	175	255	1,75

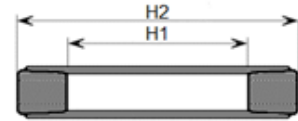

**CLOSED BODY TURNBUCKLE
DIN1478 galvanized**

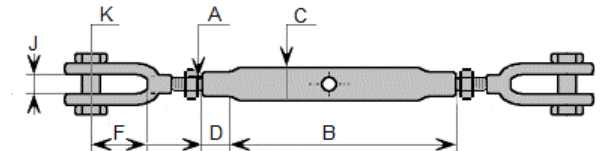

available: fork – fork

code	nominal size	approx. strength	B	C	D	F	J	K	weight
	A[mm]	[kg]	[mm]	[mm]	[mm]	[mm]	[mm]	[mm]	
SCZ08X-X	M 8	-	94	15	16	17	9	6	0,27
SCZ10X-X	M 10	300	116	21	20	27	10	8	0,45
SCZ12X-X	M 12	500	170	21	21	35	12	9	0,60
SCZ16X-X	M 16	750	200	30	29	38	19	12	1,58
SCZ20X-X	M 20	1125	229	33	12	45	20	16	2,65
SCZ24X-X	M 24	2000	325	42	16	55	28	22	4,00
SCZ30X-X	M 30	3000	210	51	40	90	47	34	8,56

STRETCHERS

WIRE STRETCHER FOR WIRE AND ROPE galvanized

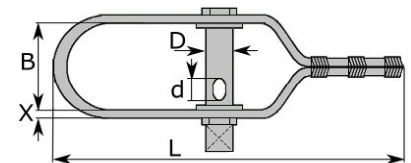

code	coating	L	X	B	d	D	weight
		[mm]	[mm]	[mm]	[mm]	[mm]	
SN090	galvanized	90	1,5	29	8	14	0,094
SNW090	galvanized	90	2	28	9	14	0,116

WIRE STRETCHER FOR WIRE AND ROPE green [RAL 6005]

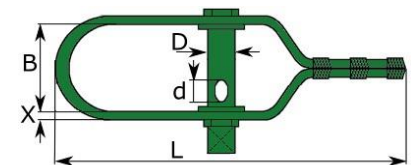

code	coating	L	X	B	d	D	weight
		[mm]	[mm]	[mm]	[mm]	[mm]	
SN090Z	green	90	1,5	29	8	14	0,097
SN092Z	green	92	1,5	27	5	10	0,067

WIRE STRETCHER FOR WIRE AND ROPE graphite [RAL 7016]

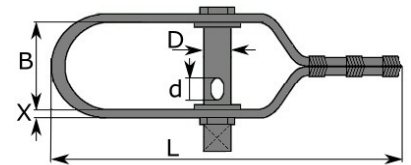

code	coating	L	X	B	d	D	weight
		[mm]	[mm]	[mm]	[mm]	[mm]	
SN090G	graphite	90	1,5	29	8	14	0,097

WIRE STRETCHER FOR WIRE AND ROPE black [RAL 9005]

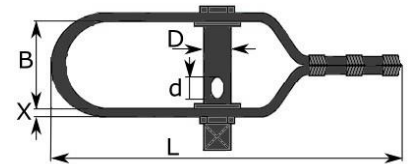

code	coating	L	X	B	d	D	weight
		[mm]	[mm]	[mm]	[mm]	[mm]	
SN090C	black	90	1,5	29	8	14	0,097

There is possibility to paint any color from the RAL palette.

Prices information are provided by phone or e-mail

*stretchers are packed of 100 pcs

*product available under the customer's special order

STAINLESS STEEL TURNBUCKLES

TURNBUCKLE type A stainless steel AISI316

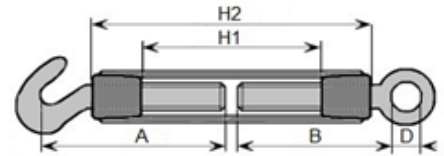

available: eye-hook

code	nominal size	max. strength	H1	H2	A	B	D	weight
		[kg]	[mm]	[mm]	[mm]	[mm]	[mm]	
NSC06X110X-X	M 6	75	87	110	76	76	9	0,10
NSC08X110X-X	M 8	140	80	110	85	81	10	0,17
NSC10X120X-X	M10	220	89	120	109	100	14	0,29
NSC12X120X-X	M12	310	84	120	112	100	17	0,42
NSC16X170X-X	M16	600	116	170	145	140	22	0,92

TURNBUCKLE CLOSED BODY stainless steel AISI316

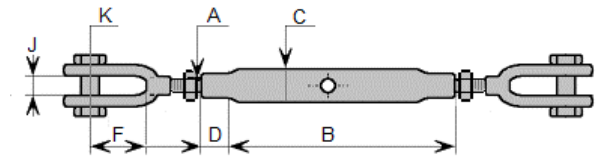

available: fork-fork

code	nominal size	max. strength	B	C	D	F	J	K	weight
	A[mm]	[kg]	[mm]	[mm]	[mm]	[mm]	[mm]	[mm]	
NSCZ06X-X	6	200	72	10	18	12	6	5	0,09
NSCZ08X-X	8	320	77	12	12	14	8	6	0,14
NSCZ10X-X	10	500	80	16	15	16	10	7	0,27
NSCZ12X-X	12	700	109	20	18	14	12	10	0,54
NSCZ16X-X	16	1200	137	24	30	24	16	12	1,00